

Gasmate®

PORTABLE DIESEL HEATER

Model No. DH203

- Powerful 2kW heating output
- Efficient diesel burner technology
- 4.25L diesel tank
- Up to 7 days of typical usage – based on 4hrs use per day, on power level 2-3
- Low 12V DC power usage
- Suitable for heating tents, camper trailers and small caravans.



Important: Retain these instructions for future use.

Gasmate® is a registered trademark of:
Sitro Group Australia Pty Ltd www.gasmate.com.au
Aber Living Ltd, N.Z www.gasmate.co.nz

04436 08/22

READ ME FIRST

IMPORTANT NOTES

This appliance is not intended for use by persons (including children) with reduced physical, sensory or mental capabilities, or lack of experience and knowledge, unless they have been given supervision or instruction concerning the use of the appliance by a person responsible for their safety.

Only use in well ventilated areas to avoid the dangerous build-up of exhaust gases. This appliance is designed for use outdoors away from any inflammable material.

The appliance must be used on a level, stable, non-flammable surface. The appliance should be protected from direct draughts.

Safety alerts labelled DANGER, WARNING and CAUTION alert you to special instructions or precautions concerning procedures that would be hazardous if performed incorrectly or carelessly.

DANGER – Immediate hazards that will result in severe injury or death.

WARNING – Hazards or unsafe practices that could result in severe personal injury or death

CAUTION – Hazards or unsafe practices that could result in minor injury, product or property damage.



DANGER

FOR OUTDOOR USE ONLY

- This heater is designed for use in well-ventilated areas.
- DO NOT use the heater in an enclosed space as it may cause the build-up of hazardous levels of carbon monoxide and result in death.
- DO NOT use with the heater unit located inside tents, caravans, marine craft, vehicles, mobile homes or similar locations.
- This heater is not designed for use in homes or other fixed buildings or structures.
- Improper installation, adjustment, alteration, service or maintenance can cause injury or property damage.



WARNING

FIRE/EXPLOSION HAZARDS

- Ensure the heater is turned OFF during refuelling.
- Only fill the fuel tank in a well-ventilated location, preferably outside, away from people and any source of ignition, such as naked flames, pilot flames, and electric heaters/equipment.

- DO NOT store or use petrol or other flammable liquids in the vicinity of this or any other appliance.
- DO NOT place items of clothing, textiles or other flammable items over the heater or in front of the air intake or hot air outlet.
- DO NOT block or restrict air flow in the ducting with rags or other materials.
- If there is a fuel leak in your appliance immediately stop the appliance, remove the appliance to a well-ventilated location away from any ignition source.
- If using the heater in grassy locations, it is best to sit the appliance on a stable and level non-combustible surface or platform and not directly on the grass.



WARNING

HOT SURFACES

- The exhaust and exhaust outlet can become very hot during operation. Keep objects well away and DO NOT touch the case areas of the heater until it has stopped and cooled down.
- The hot air ducting will heat up over time and can become hot to touch.
- Never position the duct facing directly onto children, animals or the elderly. Over time the air temperature can become hot when directed on bare skin.



CAUTION

DIESEL FUEL

- This appliance shall only be used with diesel fuel that meets the requirements of the Fuel Standard (Automotive Diesel) Determination 2019.
- Biodiesel fuel should NOT be used.
- Alpine Diesel or “Winter Diesel” is recommended to be used in cold or alpine areas to prevent waxing of the fuel and blockage of filters and the fuel system.



CAUTION

HIGH ALTITUDE USE

- The appliance operates as standard at altitudes up to 1500 m above sea level. Over this the heater should be operated in high altitude mode which can be activated via the controller.

HEATER UNIT AND SETUP

CARRY HANDLE

FUEL FILLER CAP

HOT AIR OUTLET

CONTROLLER

VENTILATION GRILL

AIR INTAKE (REAR OF UNIT)

EXHAUST OUTLET

REMOTE CONTROL

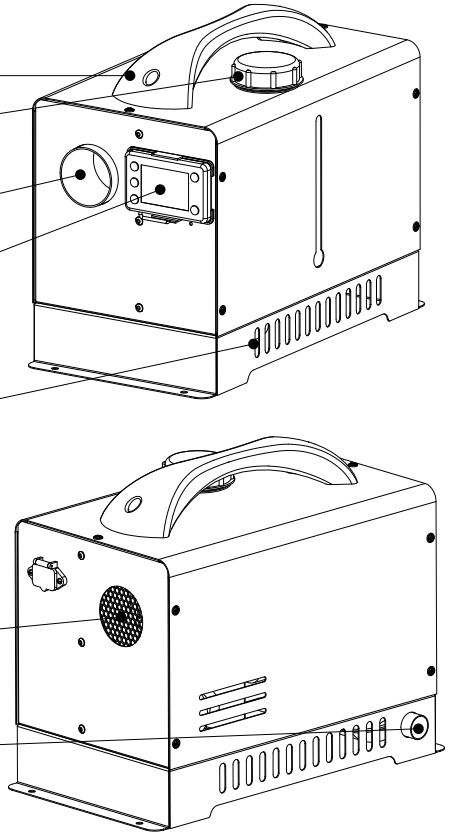

INCLUDED ACCESSORIES

- Hot air ducting – 1m long (not shown)
- 12V DC connection cable – 1m long (not shown)
- Hose clamps (not shown)
- User manual (this book)

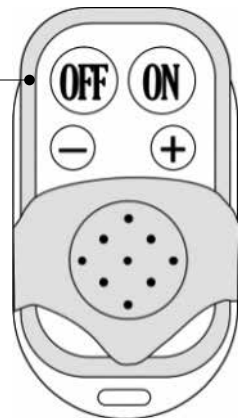

CLEARANCE & INSTALLATION

RECOMMENDED CLEARANCE

Minimum Clearances from combustible materials must be:

- Front** 200mm
- Rear** 200mm
- Sides** 200mm (see note below)
- Above** 200mm

The exhaust outlet and gasses can become very hot, and it is recommended to direct it away from any objects within 1000mm.

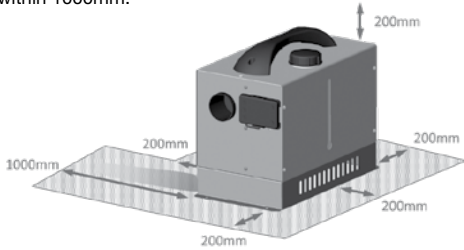

LOCATING THE HEATER FOR PORTABLE USE

As standard, the heater is designed for use as a portable unit. In this configuration, the heater unit is located in an outdoor area with the hot air duct attached to the outlet and fed into the area to be heated. The heater unit draws fresh air from outside to be heated.



DANGER

DO NOT use the heater in an enclosed space such as inside tents, caravans, marine craft, vehicles, mobile homes or similar locations as it may cause the build-up of hazardous levels of carbon monoxide and result in death.

IMPORTANT CONSIDERATIONS

The heater **MUST** be plugged into a 12V DC supply with **AT LEAST 15A** capacity to operate properly. It **CANNOT** operate from a standard 10A car cigarette socket. When choosing a location for the heater:

- The heater unit should be protected from direct exposure to rain.
- Ensure it will not interfere the operation or storage of other equipment nearby.
- Ensure it is on a smooth and level surface, away from combustible materials such as grass, leaf matter, paper, etc. Clear the area under and around the heater of any such material before use, or place the unit on a non-combustible surface.
- The exhaust outlet must point away from living spaces and from any objects within 1m.
- Ensure it is within the needed distance to a 12V power source.
- Ensure it is within the needed distance to the living space to heated.



DANGER

DO NOT use the heater on a surface containing combustible materials such as long grass, dry leaves or paper. The exhaust pipe and muffler under the unit will get very hot during operation and could result in fire.

OPERATING INSTRUCTIONS

CONTROL PANEL

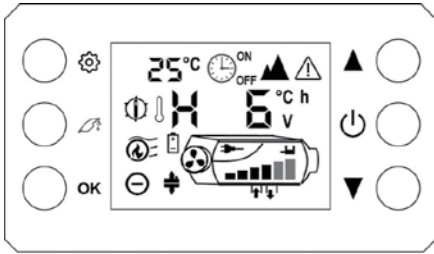

ICON DESCRIPTIONS

	Heat level control mode		Temperature control mode
	Heater operating		Input power connected
	Stand by		Fuel pump
	Glow plug		Temperature sensor
	Fan operating		Timer
	Error		High altitude mode

BUTTON FUNCTIONS

	Power	Turns the unit ON and OFF
	Increase value	Increases the selected value (can be the heating level, set temperature, or timer set point)
	Decrease value	Decreases the selected value (can be the heating level, set temperature, or timer set point)
	Settings	Changes the operating mode from heating level to temperature set-point control
	Fuel pump priming	Hold down to activate the fuel pump to prime the fuel system before first use or after fuel tank has run dry when refilled
OK	Select	Confirm a selected setting

STANDBY

When the heater is OFF and connected to DC power, the controller will show the input voltage detected in the main part of the display. It also shows the current ambient temperature detected by the controller.

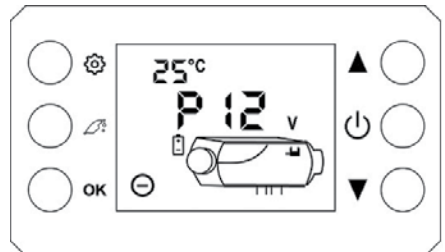

- Controller in standby showing input voltage is 12V

PRIMING THE FUEL SYSTEM (first use only)

To enable the heater to start easier on the first occasion after the fuel tank is filled, the fuel pump can be activated without starting the heater to feed the fuel into the fuel lines.

To do this hold the FUEL PUMP PRIMING () button down. It is important to monitor the fuel delivery along the fuel line to ensure the combustion chamber does not become flooded with fuel.

STARTING THE HEATER

To start the heater, press and hold the POWER () button for 2 seconds.

The heater will enter its start-up process where it will perform a system check, start pumping fuel into the combustion chamber, then activate the glow plug to initiate combustion. Once combustion is initiated, the glow plug will turn off and the heater will control as per the set mode and conditions on the control panel.

If it cannot initiate combustion, the heater will retry several times. If it still cannot initiate combustion, the heater will shut down and an error will show on the control panel (refer to troubleshooting section for details).

STOPPING THE HEATER

Once operating, the heater should be shut down by pressing and holding the POWER () button for 2 seconds.

The heater will enter its pre-set shut-down process where the pump will stop, and it will burn off the fuel in the combustion chamber then the fan will continue to run until the heater has cooled down, which can last for around 5 minutes.



WARNING

If the combustion chamber becomes flooded, some fuel may come out the exhaust pipe. During first starting the heater it may create excessive amounts of smoke for a few minutes or until the excess fuel is burnt off.



CAUTION

The heater will go through its pre-set start-up process when turned ON, which will take around 2 minutes and will operate at its maximum output. After this time, it will operate in the mode and conditions set on the control panel.

DO NOT interrupt the start-up process by cutting power to the heater.

If the heater does have the power cut during start-up it can result in excessive smoke from the exhaust when it is restarted. This should clear after a few minutes of operation.



CAUTION

The heater will go through its pre-set shut-down process when turned OFF, where the fan will continue to operate. After this time, it is safe to disconnect the heater from power and remove any ducts.



DO NOT interrupt the shut-down process by cutting power to the heater before it is completed.

If power is cut to the heater during operation or shut-down, you may see excessive smoke from the exhaust when it is restarted. This should clear after a few minutes of operation.

If it occurs regularly, it can cause carbon build-up in the combustion chamber which may result in poor combustion, inefficient operation and trouble initiating combustion.

OPERATING MODE – HEAT LEVEL

In this mode () the heater is controlled at one of 6 levels – 1 being the lowest fan speed and heat output, 6 being the maximum fan speed and heat output.

The heat level can be adjusted to a higher setting by pressing the UP () button or to a lower setting by pressing the DOWN () button.

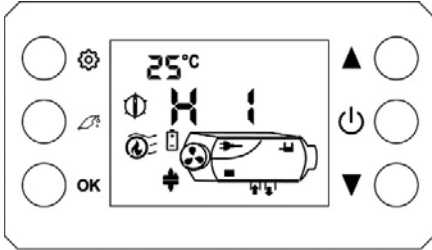

- Heater operating on heat level 1

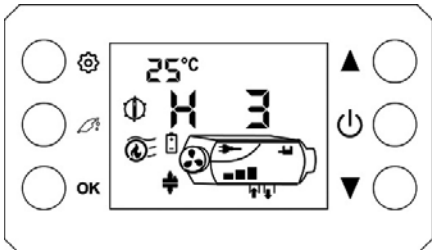

- Heater operating on heat level 3

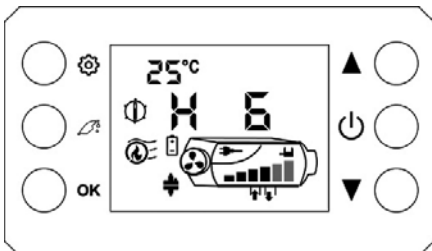



- Heater operating on heat level 6

OPERATING MODE – TEMPERATURE CONTROL

In this mode () the heater is controlled based on the difference between the set temperature and the measured room temperature. The heater will automatically adjust its heat level based on this difference.

Note: When using the heater in temperature control mode, it is important that the controller is located within the room or area being heated so the room temperature is correctly monitored

The set temperature can be adjusted to a higher temperature by pressing the UP () button or to a lower temperature by pressing the DOWN () button.

When the temperature is lower than the set temperature, the heater will operate at its maximum heat output. As the room temperature gets closer to the set temperature, the heater will adjust the heat output level down. Once the room temperature reaches or exceeds the set temperature, the heater will turn off.

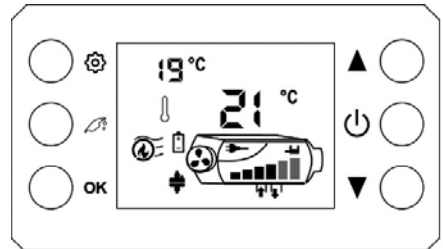

- Controller set to 21°C
- Room temperature detected at 19°C
- Heater working at power level 6 to reach the set temperature

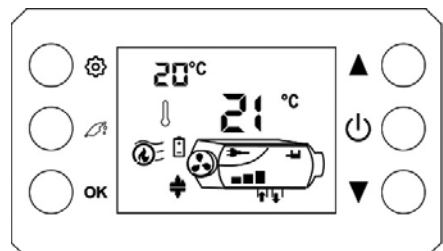

- Controller set to 21°C
- Room temperature detected at 20°C
- Heater working at power level 3 to as it is close to the set temperature

HIGH ALTITUDE MODE

When the heater is to be used in areas of high altitude for prolonged periods of time (at over 1500m above sea level), the high altitude mode (▲) should be activated to ensure reliable operation. The heater will adjust the amount of fuel supplied to the combustion chamber to balance the thinner air at high altitudes and ensure the optimal air/fuel mixture is used.

To activate the mode:

1. While the heater is in standby, press and hold the SETTINGS (⚙️) and OK (OK) buttons together for 2 seconds.
2. Once activated, you can operate the heater in the normal way.
3. To deactivate, press and hold the same 2 buttons for 2 seconds.

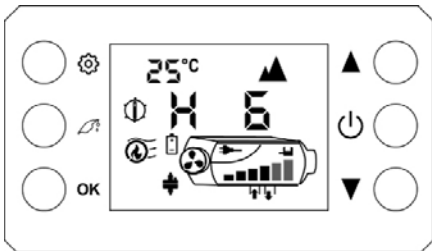

- Controller showing high altitude mode activated

REMOTE CONTROL

The supplied remote control allows basic operations within a short distance from the heater, such as inside an RV or tent with the heater unit outside.

Before attempting to pair the remote control, ensure it has a battery fitted and in good condition.

The remote control uses 12V alkaline battery of type A27 (also known as MN27, L828 & 27A). The battery can be accessed by removing the 3 rear case screws and lifting off the front of the remote case.

Before first use and each time the power is disconnected and reconnected, the remote control must be paired with the main controller by following the steps below

1. While the heater is in standby, press and hold the POWER (⏻) and DOWN (▼) buttons together for 2 seconds.
2. Use the UP (▲) or DOWN (▼) buttons to select the remote control being paired (up to 5 remote controls can be paired to the one controller). If there is only 1 remote control, select OC1 on the controller as shown below.

3. Press any button on the remote control to send a signal to the controller to pair with it.
4. Press the SELECT (OK) button to confirm and exit the pairing mode. The remote should now be paired.
5. To exit the pairing mode without saving the settings, press the SETUP (⚙️) button.

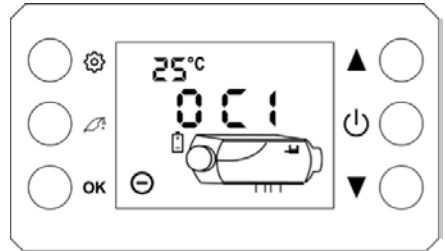

- Controller showing remote control pairing mode
- Selecting remote control 1 (OC1)

REMOTE CONTROL

The remote control buttons and functions are detailed below.

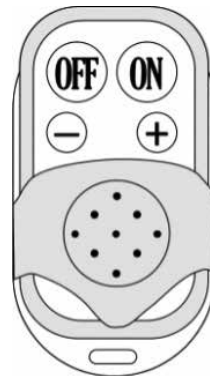

ON	Turn on	Turns the heater unit ON
OFF	Turn off	Turns the heater unit OFF
+	Increase value	Increases the selected value (heating level or set temperature)
-	Decrease value	Decreases the selected value (heating level or set temperature)

TROUBLESHOOTING

ERROR CODE	CAUSE	ACTIONS
E-2	Over-voltage or Under-voltage	Supply voltage is detected outside range (9-16V). <ul style="list-style-type: none"> • Check battery charge level and condition • Check fuse condition and connection • Check cable condition and for excessive voltage drop.
E-3	Glow plug failure	<ul style="list-style-type: none"> • Contact service support to arrange inspection or replacement of the glow plug.
E-4	Fuel pump failure	<ul style="list-style-type: none"> • Contact service support to arrange inspection or replacement of the fuel pump.
E-5	Overheating	Inlet air above 50°C or Internal heat exchanger above 230°C. <ul style="list-style-type: none"> • Allow heater to cool down, then check intake and hot air ducts for any blockage, crushing or restriction and clear and retry operation. • Contact service support to arrange inspection or replacement of the fan or temperature sensor.
E-6	Fan failure	<ul style="list-style-type: none"> • With the heater off and power disconnected, check if the impellor can rotate freely. <ul style="list-style-type: none"> - Remove anything blocking or interfering with the rotation of the fan impellor and retry operation. • Contact service support to arrange inspection or replacement of fan
E-8	Fail to start Flameout	<ul style="list-style-type: none"> • Check the current capacity of the power source is at least 15A (for example the heater will not start when powered off a regular car cigarette socket or an outlet rated under 15A) • Check the fuel level in the tank and refill if needed • Check the fuel condition, if it is old or degraded then drain the tank and replace the fuel with fresh diesel • If at low temperatures, check that correct winter or alpine diesel is used otherwise the fuel may wax up and block the pump • Check the combustion intake and exhaust openings are not blocked or damaged • Contact service support to arrange inspection or replacement of fuel system, combustion ducting and temperature sensors • If the heater had been recently used, the temperature of the heat exchanger can be too high. Allow the heater to fully cool then retry starting the heater • If during attempted start, there is allot of white smoke: <ul style="list-style-type: none"> - Contact service support to arrange inspection or replacement of the glow plug and screen and operation or the fuel pump • If during attempted start, there is little or no white smoke: <ul style="list-style-type: none"> - Check the combustion intake and exhaust openings are not blocked or damaged - Check the fuel level in the tank and refill if needed - Check the fuel condition, if it is old or degraded then drain the tank and replace the fuel with fresh diesel - If at low temperatures, check that correct winter or alpine diesel is used otherwise the fuel may wax up and block the pump - Contact service support to arrange inspection or replacement of the glow plug and screen and operation or the fuel pump • Contact service support to arrange inspection or replacement of temperature sensor
E-9	Temperature sensor failure	<ul style="list-style-type: none"> • Contact service support to arrange inspection or replacement of temperature sensor

TECHNICAL DATA

MODEL		DH203
Maximum Heating Output		2 kW
Operating Temperature		-40 to +50°C
Operating Altitude	Standard mode	Up to 1500 m above sea level
	Altitude mode	Over 1500 m above sea level
Operating Voltage		12 V DC (9-16V)
Input Power	At start-up (with glow plug on)	144 W
	Heating level 6	56 W
	Standby	7 W
Diesel Fuel Consumption	Heating level 1	0.1 L/h
	Heating level 6	0.3 L/h
Fuel Tank Capacity		4.25 L
Fuel Type		Diesel fuel that meets the requirements of the Fuel Standard (Automotive Diesel) Determination 2019
Airflow	Heating level 1	85 m ³ /h
	Heating level 6	105 m ³ /h
Unit Weight (without fuel)		9 kg
Unit Dimensions	Length	400 mm (including mounting flanges)
	Width	230 mm (including exhaust outlet)
	Height	300 mm (including carry handle)

DIAGRAMMATIC REPRESENTATIONS OF OUTDOOR AREAS

The following figures are diagrammatic representations of outdoor areas. Rectangular areas have been used in these figures – the same principles apply to any other shaped area.

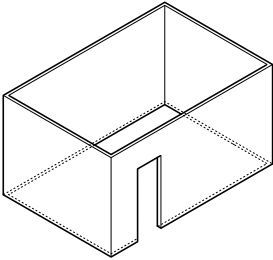

Outdoor Area - Example 1

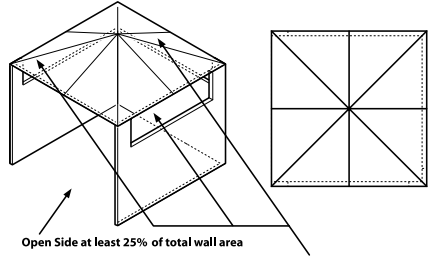
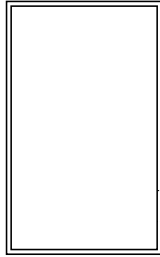

Open Side at least 25% of total wall area
30% or more in total of the remaining wall area is open and unrestricted

Outdoor Area - Example 4

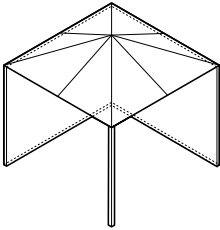

Outdoor Area - Example 2

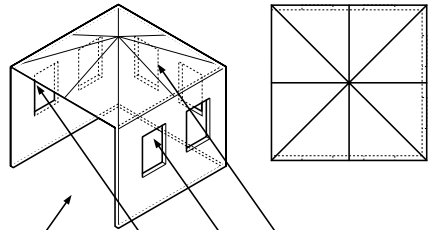
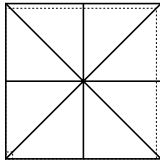

Open Side at least 25% of total wall area
30% or more in total of the remaining wall area is open and unrestricted

Outdoor Area - Example 5

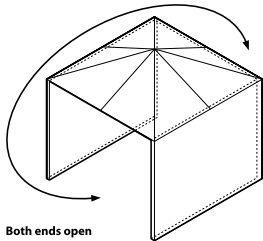

Both ends open

Outdoor Area - Example 3

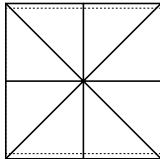

Important: Retain these instructions for future use.

For any queries or assistance call



Customer Service
(Australia Only)

1300 174 876

Hours of operation:
Monday to Friday 8am - 5pm EST

Do not return to place of purchase.
Keep your purchase receipt, this will be required to
make any claims under the 1 year warranty.

Gasmate